

## DRUM SUSPENSION

### D111060-

base number      Finish Options      Finish Options

- To build a product code in our configurator select the specify button on the base model # product page
- To build a manual product code on this datasheet choose from the options listed below in blue font and add the suffix to the base model #

#### GENERAL

Series: Drum  
 Brand: Ole  
 Division: Design  
 Mounting Type: Suspension  
 Mounting Location: Ceiling  
 Subcategory: Up/Down Light

#### PHYSICAL

Shape: Drum  
 Diameter (mm): 500  
 Diameter (in): 19 11/16  
 Height (mm): 300  
 Height (in): 11 13/16  
 Max. Overall Height (mm): 2300  
 Max. Overall Height (in): 90 9/16  
 Light Distribution: Direct / Indirect  
 Weight (kg): 2.8  
 Weight (lbs): 6.2  
 Fixture Finish: BEI / BLK / BLU / COG / DGN / GRY / MRN / MOC / MUS / OLV / SIL / STN / TER / WHI  
 Holder Finish: BLK  
 Fixture Material: Fabric Cord / Metal  
 Cable Details: 2000mm Cable  
 Upon Request: Other fabric cord colors available upon request (see downloadable finish chart)

#### ELECTRICAL

Number of Lamps: 1  
 Lamp Type: LED Retrofit  
 Lamp Shape: A19  
 Bulb Included: Bulb Not Included  
 Max. Wattage Per Lamp (W): 15  
 Lamp Base: E26  
 Input Voltage (V): 120  
 Upon Request: 277Vac / GU24

#### LED

#### OPTICAL

#### RATINGS AND CERTIFICATIONS

Certified By: Certified for North American Standards  
 IP rating: IP20

PROJECT \_\_\_\_\_  
 TYPE \_\_\_\_\_  
 SPECIFIER \_\_\_\_\_  
 QUANTITY \_\_\_\_\_  
 DATE \_\_\_\_\_

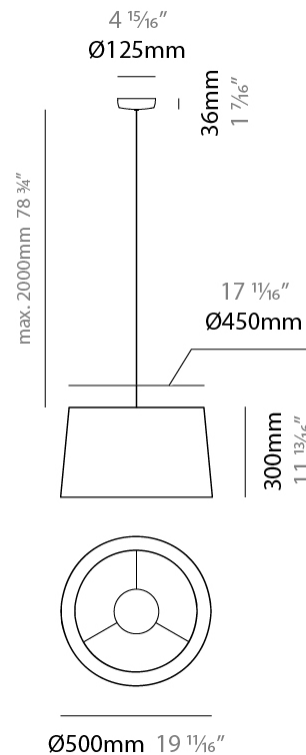

## DRUM SUSPENSION

D111060-

PROJECT

TYPE

SPECIFIER

QUANTITY

DATE

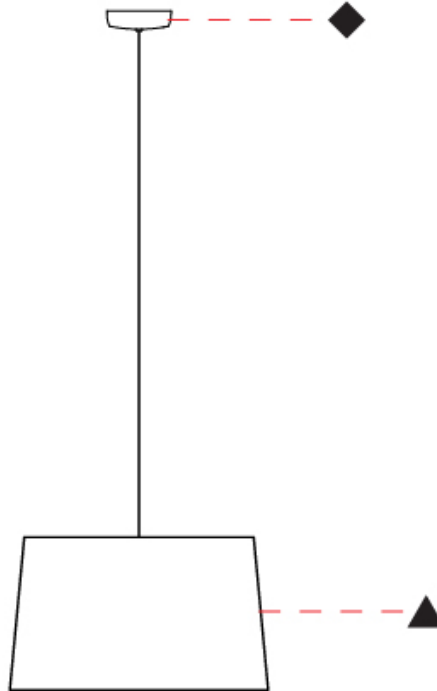

D

## DRUM SUSPENSION

**E111196-** -

base number      Finish Options      Finish Options

- To build a product code in our configurator select the specify button on the base model # product page
- To build a manual product code on this datasheet choose from the options listed below in blue font and add the suffix to the base model #

### GENERAL

Series: Drum  
 Brand: Ole  
 Division: Exterior  
 Mounting Type: Suspension  
 Mounting Location: Ceiling  
 Subcategory: Ambient

### PHYSICAL

Shape: Drum  
 Diameter (mm): 500  
 Diameter (in): 19 <sup>11</sup>/<sub>16</sub>"  
 Height (mm): 300  
 Height (in): 11 <sup>13</sup>/<sub>16</sub>"  
 Max. Overall Height (mm): 2300  
 Max. Overall Height (in): 90 <sup>9</sup>/<sub>16</sub>"  
 Light Distribution: Direct / Indirect  
 Weight (kg): 2.8  
 Weight (lbs): 6.2  
 Fixture Finish: BEI / BLK / BLU / COG / DGN / GRY / MRN / MOC / MUS / OLV / SIL / STN / TER / WHI  
 Holder Finish: BLK  
 Fixture Material: Fabric Cord / Metal  
 Cable Details: 2000mm Cable

### ELECTRICAL

Number of Lamps: 1  
 Lamp Type: LED Retrofit  
 Lamp Shape: A19  
 Bulb Included: Bulb Not Included  
 Max. Wattage Per Lamp (W): 15  
 Lamp Base: E26  
 Input Voltage (V): 120

### LED

### OPTICAL

### RATINGS AND CERTIFICATIONS

Certified By: Certified for North American Standards  
 IP rating: IP66

PROJECT
TYPE
SPECIFIER
QUANTITY
DATE

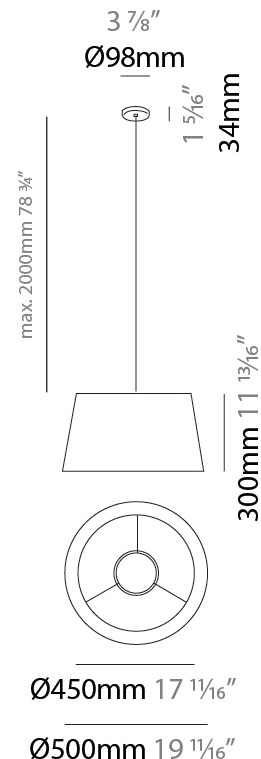

## DRUM SUSPENSION

E111196-

PROJECT

TYPE

SPECIFIER

QUANTITY

DATE

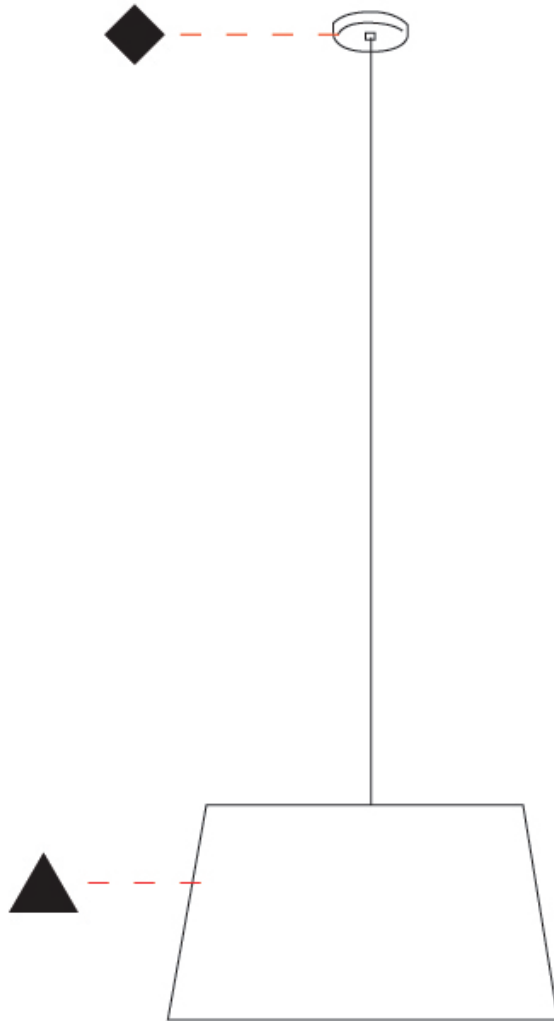

E



## DRUM

### COLOR FINISH CHART

#### Fixture Finish

Beige - BEI



Black - BLK



Blue - BLU



Cognac - COG



Dark Green - DGN

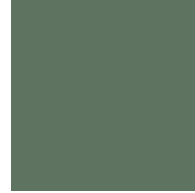

Gray - GRY



Maroon - MRN



Mocha - MOC



Mustard - MUS



Olive - OLV



Silver - SIL



Stone - STN



Terracotta - TER



White - WHI

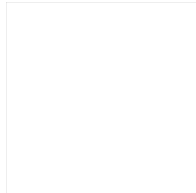

#### Holder Finish

Black - BLK



**Digital:** Not all screens are calibrated the same, and therefore, colors will appear differently between screens.

**Physical:** When texture is involved, there will be variations in color, character and tone within a product series and between product families.



## COLOR FINISH CHART



**Digital:** Not all screens are calibrated the same, and therefore, colors will appear differently between screens.  
**Physical:** When texture is involved, there will be variations in color, character and tone within a product series and between product families.

## COMPLETE COLOR FINISH CHART



Standard Colors with [S-]

Other fabric cord colors available upon request. Price increase and minimum quantities may apply

**Digital:** Not all screens are calibrated the same, and therefore, colors will appear differently between screens.

**Physical:** When texture is involved, there will be variations in color, character and tone within a product series and between product families.

Zaneen Group Inc. © 2024, T 1800-388-3382, F 416-247-9319, www.zaneen.com

Available for International specifications by adding 'INT' at the end of the existing Model #. For assistance on 'custom' specifications, contact zteam@zaneen.com.

In a constant effort to supply the best product, we reserve the right to change specifications or materials without notice. The most recent specification sheets are found at zaneen.com

## COMPLETE COLOR FINISH CHART

JADE  
 Pant. 3268C 311



VERDE BILLAR  
 Pant. 340C 353



JUNGLA  
 Pant. 356C 310



VERDE OSC.  
 Pant. 3298C 358



MUSGO  
 Pant. 5535C 320



S - DARK GREEN  
 Pant. 5616C 301



S - OLIVE  
 Pant. 5625C 323



CIRUELA  
 Pant. 368C 104



LAVANDA  
 Pant. 374C 2214



CRUDO  
 Pant. 7401C 170



OPALE  
 Pant. 402 1442



S - STONE - STN  
 Pant. 7528C 1196



ASTRACAN  
 Pant. 7529C 101



CAMELLO  
 Pant. 731C 161



CASTANO  
 Pant. 4625C 1674



TABACO  
 Pant. 1545C 203



MARRON  
 Pant. 476C 187



MARRON SUPER  
 Pant. BLACK 4C 189



MADERA  
 Pant. 7519C 2183



S - MOCHA  
 Pant. 7504C 175



AVELLANA  
 Pant. 729C 152



S - BEIGE - BEI  
 Pant. 727C 196



ARENA  
 Pant. 465C 151



BEIGE / CAMEL  
 Pant. 1265C 154



Standard Colors with [S-]

Other fabric cord colors available upon request. Price increase and minimum quantities may apply

**Digital:** Not all screens are calibrated the same, and therefore, colors will appear differently between screens.

**Physical:** When texture is involved, there will be variations in color, character and tone within a product series and between product families.

Zaneen Group Inc. © 2024, T 1800-388-3382, F 416-247-9319, www.zaneen.com

Available for International specifications by adding 'INT' at the end of the existing Model #. For assistance on 'custom' specifications, contact zteam@zaneen.com.

In a constant effort to supply the best product, we reserve the right to change specifications or materials without notice. The most recent specification sheets are found at zaneen.com

## COMPLETE COLOR FINISH CHART

ORO  
Pant. 872C 16



GOLDEN  
Pant. 7403C 7



S - MUSTARD  
Pant. 1245C 168



CANARIO  
Pant. 106C 9



MIMOSA  
Pant. 108C 15



AMARILLO  
Pant. 109U 1



NECTAR  
Pant. 137C 1871



LAVA  
Pant. 151C 1334



NARANJA  
Pant. 164C 87



S - TERRACOTTA  
Pant. 153C 205



CALABAZA  
Pant. 158C 84



ARCILLA  
Pant. 1675C 150



ROJO  
Pant. 186C 241



FUEGO  
Pant. 185C 245



SATAN  
Pant. 207C 19



S - MAROON  
Pant. 1955C 224



CLARETE  
Pant. 209C 240



BURDEOS  
Pant. 188C 163



RUBINA  
Pant. 229C 285



FRESILLA  
Pant. 695C 273



PURPURA  
Pant. 215C 276



CICLAMOR  
Pant. 205C 264



FUCSIA  
Pant. 212C 267



PESCA  
Pant. 218C 275



Standard Colors with [S-]

Other fabric cord colors available upon request. Price increase and minimum quantities may apply

**Digital:** Not all screens are calibrated the same, and therefore, colors will appear differently between screens.

**Physical:** When texture is involved, there will be variations in color, character and tone within a product series and between product families.

Zaneen Group Inc. © 2024, T 1800-388-3382, F 416-247-9319, [www.zaneen.com](http://www.zaneen.com)

Available for International specifications by adding 'INT' at the end of the existing Model #. For assistance on 'custom' specifications, contact [zteam@zaneen.com](mailto:zteam@zaneen.com).

In a constant effort to supply the best product, we reserve the right to change specifications or materials without notice. The most recent specification sheets are found at [zaneen.com](http://zaneen.com)

PROJECT \_\_\_\_\_  
TYPE \_\_\_\_\_  
NOTES \_\_\_\_\_  
QUANTITY \_\_\_\_\_  
DATE \_\_\_\_\_

## COMPLETE COLOR FINISH CHART

ROSA PASTEL  
Pant. 1905C 281



ALEJANDRIA  
Pant. 196C 261



CANET  
Pant. 2717C 43

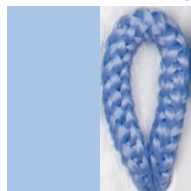

MALVA  
Pant. 2567C 141



AMORATADO  
Pant. 265C 135



LAPIZLAZULI  
Pant. 2745C 62



VIOLETA  
Pant. 7676C 147



Standard Colors with [S-]

Other fabric cord colors available upon request. Price increase and minimum quantities may apply

**Digital:** Not all screens are calibrated the same, and therefore, colors will appear differently between screens.

**Physical:** When texture is involved, there will be variations in color, character and tone within a product series and between product families.

Zaneen Group Inc. © 2024, T 1800-388-3382, F 416-247-9319, [www.zaneen.com](http://www.zaneen.com)

Available for International specifications by adding 'INT' at the end of the existing Model #. For assistance on 'custom' specifications, contact [zteam@zaneen.com](mailto:zteam@zaneen.com).

In a constant effort to supply the best product, we reserve the right to change specifications or materials without notice. The most recent specification sheets are found at [zaneen.com](http://zaneen.com)



### LEGEND

 floor-mounted	 pivotable	 special LED (upon request) RGB, RGBW, tunable, gold+, meat+, art+, fashion+
 wall and ceiling: recessed and surface mounted	 rotating	 warm dim / natural dimming LED
 ceiling-mounted and wall-mounted	 illuminate tilted	 rechargeable battery powered
 wall-mounted	 color of suspension cable	 fixture with natural vivid LED (upon request)
 omni-directional light distribution	 length of suspension cable	 color rendering index
 direct light distribution	 reflector degree selection	 color temperature
 direct/indirect light distribution	 super spot	 lumen (luminous flux)
 indirect light distribution	 lens	 efficacy (lumens per watt)
 asymmetric light distribution	 lens pack	 Unified Glare Rating (UGR) range from 5-40
 aura light distribution	 shine ring	 marine grade (AISI 316 stainless steel)
 round wall or ceiling cut-out	 integrated shine ring with diffuser	 walk on
 square wall or ceiling cut-out	 free individual colors 01-29	 drive on
 the supplied jig specifies the cutout dimensions	 individual colors: 00 (free of charge), 01-25 (extra charge)	 Dark Sky Compliance
 minimum distance (meters) lamp - object	 luminaire part to be colored (F1)	 Americans with Disabilities Act (less than 4" off the wall located between 27"-84" from floor)
 recessed depth	 luminaire part to be colored (F2)	 lamp protected against explosion
 ceiling thickness in mm	 luminaire part to be colored (F3)	 blown glass using traditional methods by master glass blower
 ceiling thickness selection	 luminaire part to be colored (F4)	 acoustic material
 dimmable DP (phase), DV (0-10V), DD (dali), DS (step-dim)	 luminaire part to be colored (F5)	 protection class I, protection insulation
 included or excluded LED driver/transformer/control gear	 color of 3-circuit adaptor	 protection class II, protection insulation
 separately switchable	 indirect diffuser	 ETL Certified to UL and CSA Standards
 sensor	 direct diffuser	 UL Certified to UL and CSA Standards
 remote control	 ball-proof (upon request)	 CSA Certified to UL and CSA Standards
 available upon request	 accessory	 Certified for North American Standards

### IP RATING

 IP20	protected against ingress of solid bodies greater than 12.5mm (finger)
 IP33	protected against ingress of solid bodies greater than 2.5mm protected against sprays of water up to 60 degrees from the vertical (rain)
 IP40	protected against ingress of solid bodies greater than 1mm (wire) no protection against the ingress of moisture
 IP43	protected against ingress of solid bodies greater than 1mm (wire) protected against sprays of water up to 60 degrees from the vertical (rain)
 IP44	protected against ingress of solid bodies greater than 1mm (wire) protected against water splashed from all directions
 IP54	protected against limited ingress of dust (wet rooms/covered outdoor areas) protected against water splashed from all directions
 IP65	protected against ingress of dust protected against jets of water
 IP66	protected against ingress of dust protected against powerful jets of water or heavy seas
 IP67	protected against ingress of dust protected against immersion of water between 15cm - 1m for 30 minutes
 IP68	protected against ingress of dust protected against immersion of water under pressure for long periods

### IK RATING

 IK01	protected against 0.14 joules impact (equivalent to 0.25kg mass dropped from 56mm above the surface)
 IK02	protected against 0.2 joules impact (equivalent to 0.25kg mass dropped from 80mm above the surface)
 IK03	protected against 0.35 joules impact (equivalent to 0.25kg mass dropped from 140mm above the surface)
 IK04	protected against 0.5 joules impact (equivalent to 0.25kg mass dropped from 200mm above the surface)
 IK05	protected against 0.7 joules impact (equivalent to 0.25kg mass dropped from 280mm above the surface)
 IK06	protected against 1 joules impact (equivalent to 0.25kg mass dropped from 400mm above the surface)
 IK07	protected against 2 joules impact (equivalent to 0.5kg mass dropped from 400mm above the surface)
 IK08	protected against 5 joules impact (equivalent to 1.7kg mass dropped from 300mm above the surface)
 IK09	protected against 10 joules impact (equivalent to 5.0kg mass dropped from 200mm above the surface)
 IK10	protected against 20 joules impact (equivalent to 5.0kg mass dropped from 400mm above the surface)